

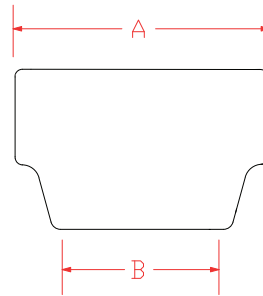

Air Spacer

Standard Profile Air Spacer (W)



Laser-welded air spacers are available in mill finish, clear, light bronze, dark bronze, black and gold anodized aluminum, and galvanized and HY-NZ (Nickel Zinc coated) steel. Spacers can be imprinted or cut-to-length. Zipper welds or solid welds with perforated top can be specified.

Standard lengths are 12'8" or 13' depending on the profile.

Related Connectors

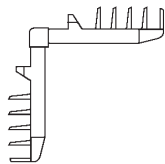

**Nylon FlexiFin
Fixed 90° Corner Key**

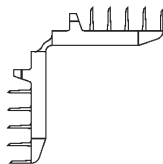

**Nylon FlexiFin
Bending Corner Key**

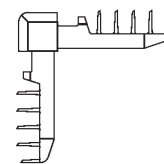

**Glass Filled Nylon
Wraparound Corner Key**

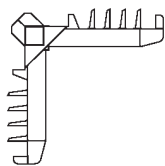

Butyl Inject Corner Key

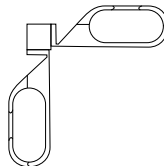

Zinc Corner Key

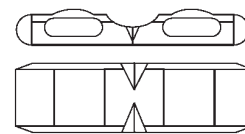

**Nylon Straight
Connector**

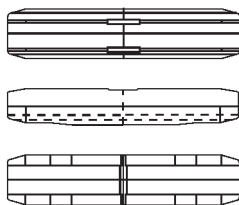

**Nylon Straight Connector
Pass Desiccant**



Air Spacer

Standard Profile Air Spacer (W)

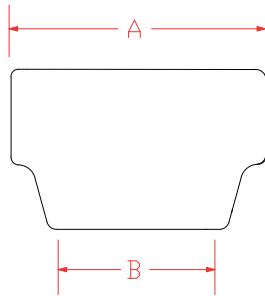

Part Number	Fractional Size	Air Space in Inches (A)	(B) in Inches	Pieces per Carton	Linear Feet per Carton based on 152"
W188	3/16	0.188	0.070	350	4,434
W219	7/32	0.219	0.070	325	4,117
W235	15/64	0.235	0.075	450	5,850
W250	1/4	0.250	0.100	450	5,700
W281	9/32	0.281	0.110	415	5,395
W297	19/64	0.297	0.115	375	4,875
W312	5/16	0.312	0.130	375	4,750
W344	11/32	0.344	0.145	325	4,225
W360	23/64	0.360	0.160	300	3,900
W375	3/8	0.375	0.175	300	3,800
W406	13/32	0.406	0.200	285	3,705
W438	7/16	0.438	0.212	252	3,192
W469	15/32	0.469	0.230	220	2,860
W485	31/64	0.485	0.275	228	2,964
W500	1/2	0.500	0.300	225	2,850
W520		0.520	0.320	225	2,925
W531	17/32	0.531	0.330	198	2,508
W548	35/64	0.548	0.335	209	2,647
W563	9/16	0.563	0.340	198	2,508
W594	19/32	0.594	0.370	190	2,470
W610	39/64	0.610	0.385	180	2,340
W625	5/8	0.625	0.400	180	2,280
W656	21/32	0.656	0.450	171	2,223
W688	11/16	0.688	0.500	162	2,052
W719	23/32	0.719	0.530	152	1,925
W750	3/4	0.750	0.575	144	1,824
W781	25/32	0.781	0.580	144	1,824
W812	13/16	0.812	0.585	133	1,685
W875	7/8	0.875	0.650	120	1,560
W1000	1	1.000	0.775	114	1,482
W1312	1 5/16	1.312	1.080	84	1,092

Air Spacer



Air Spacer

Standard Profile Air Spacer (W)

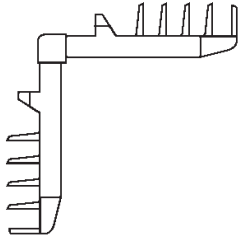

**Nylon FlexiFin
Fixed 90° Corner Key**

Spacer Part Number	Fractional Size	Key Part Number	Pieces per Box
W188	3/16	DW188P	4,500
W219	7/32	DW188P	4,500
W235	15/64	DW235P	3,300
W250	1/4	DW250P	11,000
W281	9/32	DW281P	3,000
W297	19/64	DW297P	10,000
W312	5/16	DW312P-1	2,800
W344	11/32	DW344P	2,400
W360	23/64	DW375P	7,000
W375	3/8	DW375P	7,000
W406	13/32	DW375P	7,000
W438	7/16	DW438P	6,000
W469	15/32	DW438P	6,000
W485	31/64	DW500P	6,000
W500	1/2	DW500P	6,000
W520		DW500P	6,000
W531	17/32	DW531P	5,000
W548	35/64	DW531P	5,000
W563	9/16	DW563P	5,000
W594	19/32	DW563P	5,000
W610	39/64	DW625P	4,000
W625	5/8	DW625P	4,000
W656	21/32	DW656P	4,000
W688	11/16	DW688P	4,000
W719	23/32	DW688P	4,000
W750	3/4	DW750P	3,500
W781	25/32	DW750P	3,500
W812	13/16	DW812P	3,300
W875	7/8	DW875P	3,000
W1000	1	DW1000P	1,200
W1063	1 5/16	DW1063P	1,200



Air Spacer

Standard Profile Air Spacer (W)

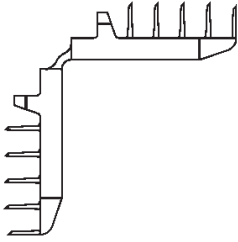

**Nylon FlexiFin
Bending Corner Key**

Spacer Part Number	Fractional Size	Key Part Number	Pieces per Box
W235	15/64	D250SW	7,000
W250	1/4	D250SW	7,000
W312	5/16	D312SW	5,000
W360	23/64	D375SW	4,000
W375	3/8	D375SW	4,000
W438	7/16	D438SW	3,200
W469	15/32	D438SW	3,200
W485	31/64	D500SW	2,600
W500	1/2	D500SW	2,600
W520		D500SW	2,600
W563	9/16	D563SW	2,400
W594	19/32	D563SW	2,400
W610	5/8	D625SW	2,400
W625	21/32	D625SW	2,400
W688	11/16	D688SW	2,000
W750	3/4	D750SW	1,600
W781	25/32	D750SW	1,600



Air Spacer

Standard Profile Air Spacer (W)

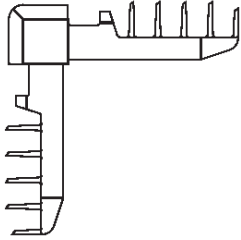

**Glass Filled Nylon
Wraparound Corner Key**

Spacer Part Number	Fractional Size	Key Part Number	Pieces per Box
W188	3/16	D188ATGF	1,200
W219	7/32	D219ATGF	1,200 / 4,200
W235	15/64	D235ATGF-1	3,800
W250	1/4	D250ATGF	1,000
W281	9/32	D281ATGF	1,000 / 3,300
W312	5/16	D312ATGF-1	3,000
W344	11/32	D344ATGF-1	2,700
W360	23/64	D359ATGF-1	2,600
W375	3/8	D375ATGF-1	700 / 2,400
W406	13/32	D406ATGF-1	2,200
W438	7/16	D438ATGF-1	1,900
W469	15/32	D469ATGF-1	1,800
W485	31/64	D485ATGF-1	1,800
W500	1/2	D500ATGF	500 / 1,700
W520		D516ATGF-1	1,600
W531	17/32	D531ATGF-1	1,500
W548	35/64	D547ATGF-1	1,500
W563	9/16	D563ATGF-1	1,400
W594	19/32	D594ATGF-1	1,300
W625	5/8	D625ATGF	400 / 1,300
W656	21/32	D656ATGF-1	1,200
W688	11/16	D688ATGF-1	1,100
W719	23/32	D719ATGF-1	1,000
W750	3/4	D750ATGF	300



Air Spacer

Standard Profile Air Spacer (W)

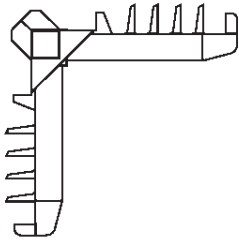

Butyl Inject Corner Key

Spacer Part Number	Fractional Size	Key Part Number	Pieces per Box
W219	7/32	DW219PBB	1,400
W250	1/4	DW250PBB	1,100
W281	9/32	DW281PBB	1,000
W312	5/16	DW312PBB	900
W344	11/32	DW344PBB	800 / 2,700
W375	3/8	DW375PBB	700
W406	13/32	DW406PBB	600
W438	7/16	DW438PBB	600
W469	15/32	DW469PBB	500
W500	1/2	DW500PBB	1,700
W531	17/32	DW531PBB	500
W563	9/16	DW563PBB	400
W594	19/32	DW594PBB	400
W625	5/8	DW625PBB-1	1,400
W656	21/32	DW656PBB	400
W688	11/16	DW688PBB	300
W719	23/32	DW719PBB	300
W750	3/4	DW750PBB-1	1,000
W781	25/32	DW781PBB	300
W812	13/16	DW812PBB	300



Air Spacer

Standard Profile Air Spacer (W)

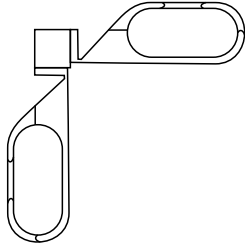

Zinc Corner Key

Spacer Part Number	Fractional Size	Key Part Number	Pieces per Box
W188	3/16	D2424	9,500
W219	7/32	D2424	9,500
W235	15/64	DW250B	3,400
W250	1/4	DW250B	3,400
W312	5/16	DW312B	2,500
W360	23/64	DW375B	2,200
W375	3/8	DW375B	2,200
W438	7/16	DW438B	1,700
W469	15/32	DW438B	1,700
W485	31/64	DW500B	1,400
W500	1/2	DW500B	1,400
W520		DW500B	1,400
W563	9/16	DW563B	1,200
W594	19/32	DW563B	1,200
W610	39/64	DW625B	1,100
W625	5/8	DW625B	1,100
W688	11/16	DW688B	1,000
W750	3/4	DW750B	900
W781	25/32	DW750B	900



Air Spacer

Standard Profile Air Spacer (W)

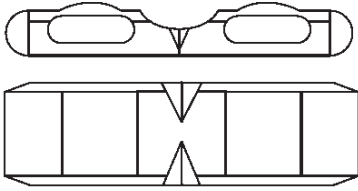

Nylon Straight Connector

Spacer Part Number	Fractional Size	Key Part Number	Pieces per Box
W250	1/4	DW250ST	12,000
W500	1/2	DW500ST	5,000
W625	5/8	DW625ST	4,000
W688	11/16	DW688ST	3,000
W719	23/32	DW719ST-1	3,500
W812	13/16	DW812ST	5,000



Air Spacer

Standard Profile Air Spacer (W)

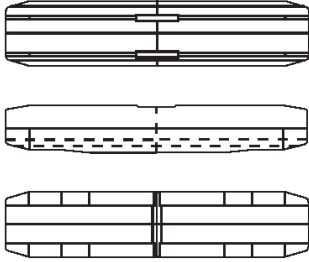

**Nylon Straight Connector
Pass Desiccant**

Spacer Part Number	Fractional Size	Key Part Number	Pieces per Box
W188	3/16	DW188MPSTPD-1	8,000
W250	1/4	DW250MPSTPD-1	6,500
W312	5/16	DW312MPSTPD-1	6,000
W344	11/32	DW344MPSTPD	1,700
W375	3/8	DW375MPSTPD	1,600
W438	7/16	DW438MPSTPD	900 / 3,200
W469	15/32	DW469MPSTPD	800
W500	1/2	DW500MPSTPD-1	2,800
W531	17/32	DW531MPSTPD	700
W563	9/16	DW563MPSTPD-1	2,400
W594	19/32	DW594MPSTPD-1	2,400
W625	5/8	DW625MPSTPD-1	2,300
W656	21/32	DW656MPSTPD	600
W688	11/16	DW688MPSTPD-1	2,100
W719	23/32	DW719MPSTPD-1	2,000
W750	3/4	DW750MPSTPD	600
W1000	1	DW1000MPSTPD	1,500



Air Spacer

Low Profile Air Spacer (WF)

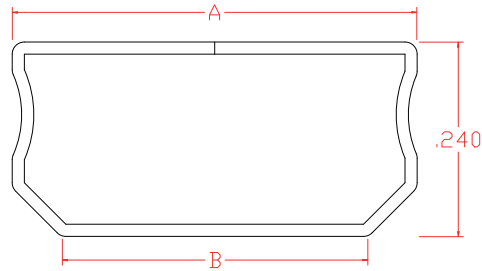

Laser-welded air spacers are available in mill finish, clear, light bronze, dark bronze, black and gold anodized aluminum, and galvanized and HY-NZ (Nickel Zinc coated) steel. Spacers can be imprinted or cut-to-length. Zipper welds or solid welds with perforated top can be specified.

Standard lengths are 12'8" or 13' depending on the profile.

Related Connectors

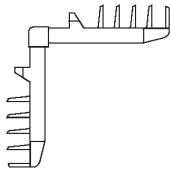

**Nylon FlexiFin
Fixed 90° Corner Key**

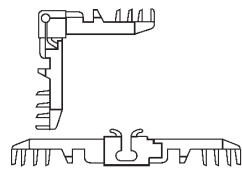

**Nylon Fold & Lock
Corner Key**

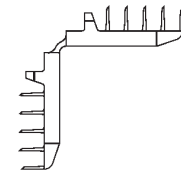

**Nylon FlexiFin
Bending Corner Key**

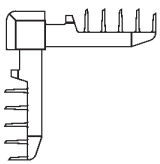

**Glass Filled Nylon
Wraparound Corner Key**

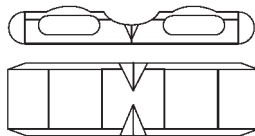

**Plastic Straight
Connector**

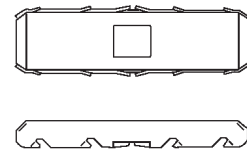

**Steel Straight
Connector**



Air Spacer

Low Profile Air Spacer (WF)

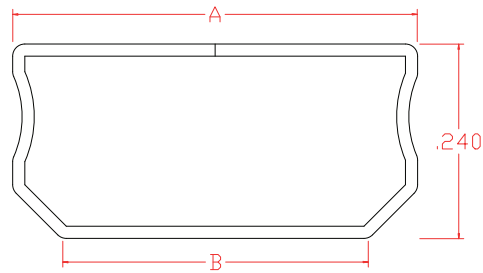

Part Number	Fractional Size	Air Space in Inches (A)	(B) in Inches	Pieces per Carton	Linear Feet per Carton based on 156"
WF188	3/16	0.188	0.068	425	5,525
WF219	7/32	0.219	0.100	350	4,550
WF250	1/4	0.250	0.130	550	7,150
WF266	17/64	0.266	0.146	400	5,200
WF281	9/32	0.281	0.161	500	6,500
WF297	19/64	0.297	0.176	500	6,500
WF312	5/16	0.312	0.192	425	5,525
WF344	11/32	0.344	0.224	400	5,200
WF360	23/64	0.380	0.240	400	5,200
WF375	3/8	0.375	0.255	375	4,875
WF406	13/32	0.406	0.286	350	4,550
WF438	7/16	0.438	0.311	344	4,472
WF469	15/32	0.469	0.349	290	3,770
WF500	1/2	0.500	0.380	288	3,744
WF531	17/32	0.531	0.411	275	3,575
WF563	9/16	0.563	0.443	240	3,120
WF594	19/32	0.594	0.474	240	3,120
WF610	39/64	0.610	0.490	225	2,925
WF625	5/8	0.625	0.505	225	2,925
WF656	21/32	0.656	0.536	225	2,925
WF688	11/16	0.688	0.588	200	2,600
WF719	23/32	0.719	0.599	192	2,496
WF728		0.728	0.608	200	2,600
WF750	3/4	0.750	0.630	200	2,600
WF781	25/32	0.781	0.661	192	2,496
WF812	13/16	0.812	0.692	175	2,275



Air Spacer

Low Profile Air Spacer (WF)

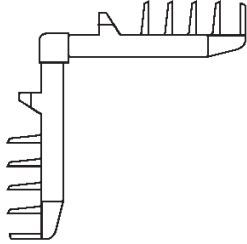

**Nylon FlexiFin
Fixed 90° Corner Key**

Spacer Part Number	Fractional Size	Key Part Number	Pieces per Box
WF188	3/16	DF188P	3,500
WF219	7/32	DF219P	10,000
WF250	1/4	DF250P	3,700
WF266	17/64	DF250P	3,700
WF281	9/32	DF281P	7,500
WF297	19/64	DF312P	3,200
WF312	5/16	DF312P	3,200
WF344	11/32	DF344P	6,000
WF360	23/64	DF375P	2,500
WF375	3/8	DF375P	2,500
WF406	13/32	DF375P	2,500
WF438	7/16	DF438P	7,500
WF469	15/32	DF469P	3,800
WF500	1/2	DF500P	6,000
WF531	17/32	DF500P	6,000
WF563	9/16	DF563P	5,500
WF594	19/32	DF563P	5,500
WF610	39/64	DF625P	5,000
WF625	5/8	DF625P	5,000
WF656	21/32	DF625P	5,000
WF688	11/16	DF688P	5,000
WF719	23/32	DF719P	2,500
WF728		DF750P	4,000
WF750	3/4	DF750P	4,000
WF781	25/32	DF750P	4,000
WF812	13/16	DF812P	2,200



Air Spacer

Low Profile Air Spacer (WF)

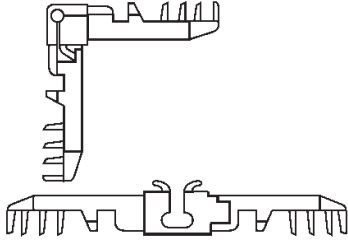

Nylon Fold & Lock Corner Key

Spacer Part Number	Fractional Size	Key Part Number	Pieces per Box
WF188	3/16	DF188A	7,000
WF219	7/32	DF219A	6,000
WF250	1/4	DF250A	5,000
WF266	17/64	DF266A	4,600
WF281	9/32	DF281A	4,400
WF297	19/64	DF297A	4,300
WF312	5/16	DF312A	4,200
WF344	11/32	DF344A	4,000
WF360	23/64	DF375A	3,500
WF375	3/8	DF375A	3,500
WF406	13/32	DF406A	3,200
WF438	7/16	DF438A	3,000
WF469	15/32	DF469A	2,600
WF500	1/2	DF500A	2,500
WF531	17/32	DF531A	2,300
WF563	9/16	DF563A	2,300
WF594	19/32	DF594A	2,200
WF610	39/64	DF594A	2,200
WF625	5/8	DF625A	2,000
WF656	21/32	DF656A	1,900
WF688	11/16	DF688A	1,800
WF719	23/32	DF719A	1,700
WF728		DF719A	1,700
WF750	3/4	DF750A	1,600
WF781	25/32	DF781A	1,500
WF812	13/16	DF812A	1,500



Air Spacer

Low Profile Air Spacer (WF)

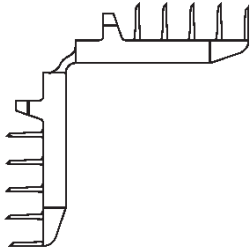

**Nylon FlexiFin
Bending Corner Key**

Spacer Part Number	Fractional Size	Key Part Number	Pieces per Box
WF188	3/16	DF188SWA-1	3,500
WF219	7/32	DF219SWA	10,000
WF250	1/4	DF250SWA	8,500
WF281	9/32	DF281SWA	7,500
WF312	5/16	DF312SWA	6,000
WF344	11/32	DF344SWA	6,000
WF375	3/8	DF375SWA	5,000
WF406	13/32	DF406SWA	4,600
WF438	7/16	DF438SWA	4,200
WF469	15/32	DF469SWA	3,800
WF500	1/2	DF500SWA	3,600
WF531	17/32	DF531SWA	3,400
WF563	9/16	DF563SWA	3,200
WF594	19/32	DF594SWA	3,000
WF625	5/8	DF625SWA	3,000
WF656	21/32	DF656SWA	2,800
WF688	11/16	DF688SWA	2,800
WF719	23/32	DF719SWA	2,500
WF750	3/4	DF750SWA	2,400
WF781	25/32	DF781SWA	2,200
WF812	13/16	DF812SWA	2,200



Low Profile Air Spacer (WF)

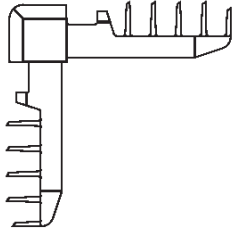

**Glass Filled Nylon
Wraparound Corner Key**

Spacer Part Number	Fractional Size	Key Part Number	Pieces per Box
WF219	7/32	DF219AN	2,400
WF250	1/4	DF250AN	2,000
WF312	5/16	DF312AN	1,500
WF344	11/32	DF344AN	1,300
WF375	3/8	DF375AN	1,200
WF438	7/16	DF438AN	1,000
WF469	15/32	DF469AN	900
WF500	1/2	DF500AN	900
WF563	9/16	DF563AN	800
WF594	19/32	DF594AN	700
WF625	5/8	DF625AN	700
WF688	11/16	DF688AN	600
WF719	23/32	DF719AN	500
WF750	3/4	DF750AN	500
WF812	13/16	DF812AN	400



Air Spacer

Low Profile Air Spacer (WF)

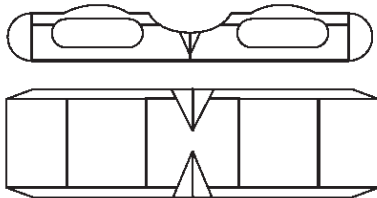

Nylon Straight Connector

Spacer Part Number	Fractional Size	Key Part Number	Pieces per Box
WF188	3/16	DF188ST	2,000
WF219	7/32	DF219ST-1	7,000
WF250	1/4	DF250ST-1	6,500
WF281	9/32	DF281ST-1	6,000
WF312	5/16	DF312ST-1	4,800
WF344	11/32	DF344ST-1	4,700
WF375	3/8	DF375ST-1	4,500
WF406	13/32	DF406ST-1	4,300
WF438	7/16	DF438ST-1	4,000
WF469	15/32	DF469ST-1	3,900
WF500	1/2	DF500ST-1	3,800
WF531	17/32	DF531ST-1	3,600
WF563	9/16	DF563ST-1	3,400
WF594	19/32	DF594ST-1	3,200
WF625	5/8	DF625ST-1	3,000
WF656	21/32	DF656ST-1	2,800
WF688	11/16	DF688ST-1	2,500
WF719	23/32	DF719ST-1	2,200
WF750	3/4	DF750ST-1	2,000
WF781	25/32	DF781ST-1	1,800
WF812	13/16	DF812ST	4,000



Air Spacer

Low Profile Air Spacer (WF)

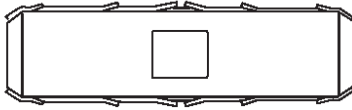

Steel Straight Connector

Spacer Part Number	Fractional Size	Key Part Number	Pieces per Box
WF188	3/16	DF4.5ST	2,500
WF219	7/32	DF5.5ST	2,500
WF281	9/32	DF7.0STM	2,500
WF312	5/16	DF8.0ST	2,500
WF344	11/32	DF8.5ST	2,500
WF375	3/8	DF9.5ST	2,500
WF406	13/32	DF10.5STM	2,500
WF438	7/16	DF11.0ST	2,500
WF469	15/32	DF11.5ST	2,600
WF500	1/2	DF12.5ST	2,500
WF531	17/32	DF14.0STM	2,500
WF563	9/16	DF14.5ST	2,500
WF594	19/32	DF15.0STM	2,500
WF625	5/8	DF16.0ST	2,000
WF656	21/32	DF17.0STAM	1,500
WF688	11/16	DF17.5ST	1,500
WF719	23/32	DF18.5STAM	1,500
WF750	3/4	DF19.0ST	1,500
WF781	25/32	DF19.5ST-1	1,500



Air Spacer

WLPA Low Profile Air Spacer

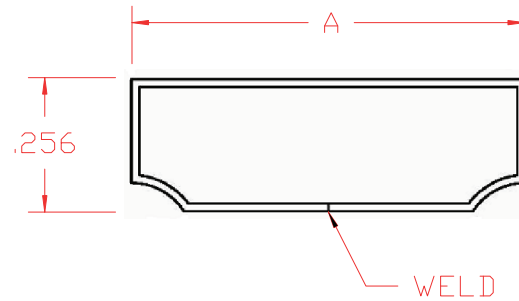

WLPA induction welded air spacers are available in mill finish, clear, light bronze, dark bronze, black, gold anodized aluminum. Painted top spacers are available subject to minimum volumes. WLPA spacers can be imprinted and are available subject to minimum volumes. WLPA low profile spacers are ideal for bending and automated bending applications.

Standard lengths are 5 meters or 16.4'.

WLPA 3D Profile

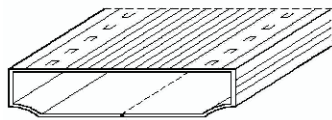

WLPA Top View

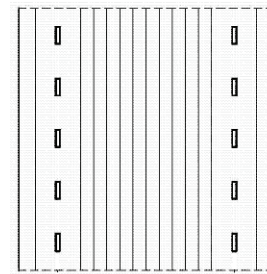

Related Connectors

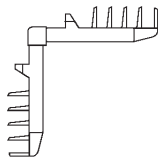

**Nylon FlexiFin
Fixed 90° Corner Key**

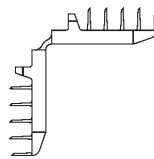

**Nylon FlexiFin
Bending Corner Key**

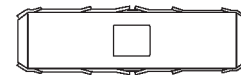

**Steel Straight
Connector**



Air Spacer

WLPA Low Profile Air Spacer

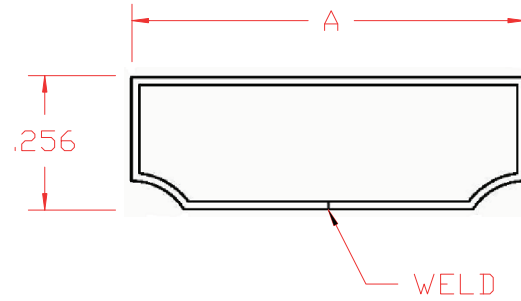

Part Number	Fractional Size	Air Space in Inches (A)	Air Space in MM	Pieces per Carton	Linear Feet per Carton based on 16.3"
WLPA156	5/32	0.156	4.0	450	5,525
WLPA219	7/32	0.219	5.5	600	4,550
WLPA250	1/4	0.250	6.5	540	7,150
WLPA312	5/16	0.312	7.75	480	5,200
WLPA375	3/8	0.375	9.5	360	6,500
WLPA438	7/16	0.438	11.2	300	6,500
WLPA469	15/32	0.469	11.5	300	5,525
WLPA500	1/2	0.500	12.5	280	5,200
WLPA531	17/32	0.531	13.5	260	5,200
WLPA563	9/16	0.563	14.5	240	4,875
WLPA625	5/8	0.625	15.5	220	4,550
WLPA688	11/16	0.688	17.5	200	4,472
WLPA750	3/4	0.750	19.2	180	3,770
WLPA812	13/16	0.812	20.5	160	3,744
WLPA938	15/16	0.938	23.5	132	3,575



Air Spacer

WLPA Low Profile Air Spacer

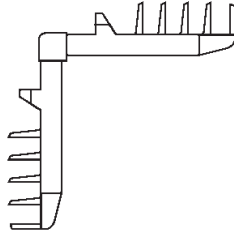

**Nylon FlexiFin
Fixed 90° Corner Key**

Part Number	Fractional Size	Air Space in MM	Key Part Number	Pieces per Box
WLPA156	5/32	4.0	DWLPA156P	5,000
WLPA219	7/32	5.5	DWLPA219P	5,000
WLPA250	1/4	6.5	DWLPA250P	5,000
WLPA312	5/16	7.75	DWLPA312P	5,000
WLPA375	3/8	9.5	DWLPA375P	5,000
WLPA438	7/16	11.2	DWLPA438P	5,000
WLPA500	1/2	12.5	DWLPA500P	5,000
WLPA531	17/32	13.5	DWLPA531P	5,000
WLPA563	9/16	14.5	DWLPA563P	5,000
WLPA625	5/8	15.5	DWLPA625P	5,000
WLPA688	11/16	17.5	DWLPA688P	5,000
WLPA750	3/4	19.2	DWLPA750P	5,000
WLPA938	15/16	23.5	DWLPA938P	5,000



WLPA Low Profile Air Spacer

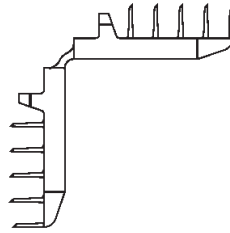

**Nylon FlexiFin
Bending Corner Key**

Part Number	Fractional Size	Air Space in MM	Key Part Number	Pieces per Box
WLPA250	1/4	6.5	DW250LPSWA	2,400
WLPA312	5/16	7.75	DW312LPSWA	2,000
WLPA375	3/8	9.5	DW375LPSWA	1,500
WLPA438	7/16	11.2	DW438LPSWA	1,200
WLPA500	1/2	12.5	DW500LPSWA	1,000
WLPA563	9/16	14.5	DW563LPSWA	900
WLPA625	5/8	15.5	DW625LPSWA	800
WLPA688	11/16	17.5	DW688LPSWA	700
WLPA750	3/4	19.2	DW750LPSWA	600



Air Spacer

WLPA Low Profile Air Spacer

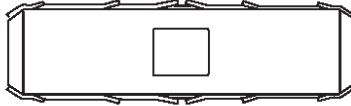

Steel Straight Connector

Part Number	Fractional Size	Air Space in MM	Key Part Number	Pieces per Box
WLPA250	1/4	6.5	DWLPA250ST	2,500
WLPA312	5/16	7.75	DWLPA312ST	2,500
WLPA375	3/8	9.5	DWLPA375ST	2,500
WLPA438	7/16	11.2	DWLPA438ST	2,500
WLPA469	15/32	11.5	DWLPA469ST	2,500
WLPA500	1/2	12.5	DWLPA500ST	2,500
WLPA531	17/32	13.5	DWLPA531ST	2,500
WLPA563	9/16	14.5	DWLPA563ST	2,500
WLPA625	5/8	15.5	DWLPA625ST	2,000
WLPA688	11/16	17.5	DWLPA688ST	1,500
WLPA750	3/4	19.2	DWLPA750ST	1,500
WLPA938	15/16	23.5	DWLPA938ST	1,500

Air Spacer



Air Spacer

A-Profile Air Spacer

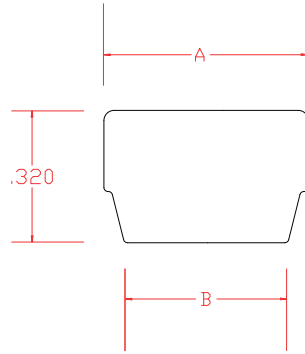

Laser-welded air spacers are available in mill finish, clear, light bronze, dark bronze, black and gold anodized aluminum, and galvanized and HY-NZ (Nickel Zinc coated) steel. Spacers can be imprinted or cut-to-length. Zipper welds or solid welds with perforated top can be specified.

Standard lengths are 12'8" or 13' depending on the profile.

Related Connectors

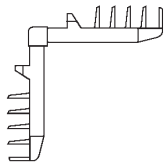

**Nylon FlexiFin
Fixed 90° Corner Key**

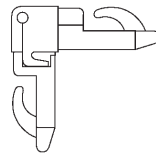

**Nylon Fold & Lock
Corner Key with Hook**

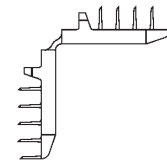

**Nylon FlexiFin
Bending Corner Key**

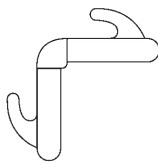

**Nylon Fixed 90°
Corner Key with Hook**

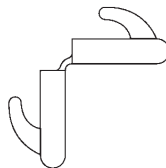

**Nylon Bending
Corner Key with Hook**

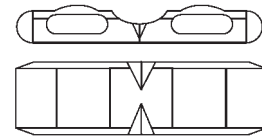

**Nylon Straight
Connector**

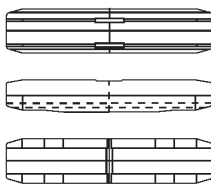

**Nylon Straight Connector -
Pass Desiccant**

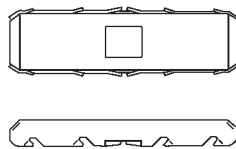

Steel Straight Connector



Air Spacer

A-Profile Air Spacer

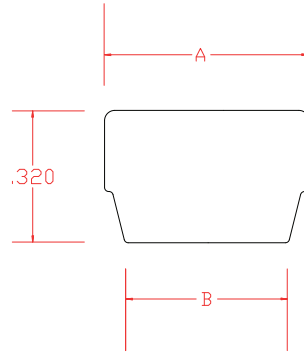

Part Number	Fractional Size	Air Space in Inches (A)	(B) in Inches	Pieces per Carton	Linear Feet per Carton based on 152"
W188A	3/16	0.188	0.088	350	4,434
W219A	7/32	0.219	0.119	285	3,610
W250A	1/4	0.250	0.150	450	5,700
W281A	9/32	0.281	0.181	350	4,434
W297A	19/64	0.297	0.197	375	4,750
W312A	5/16	0.312	0.213	350	4,434
W344A	11/32	0.344	0.244	325	4,117
W360A	23/64	0.360	0.260	275	3,483
W375A	3/8	0.375	0.275	285	3,610
W406A	13/32	0.406	0.306	275	3,484
W438A	7/16	0.438	0.338	252	3,192
W469A	15/32	0.469	0.369	234	2,964
W500A	1/2	0.500	0.400	216	2,736
W531A	17/32	0.531	0.431	190	2,407
W563A	9/16	0.563	0.463	198	2,508
W594A	19/32	0.594	0.494	180	2,280
W625A	5/8	0.625	0.525	180	2,280
W656A	21/32	0.656	0.556	162	2,052
W688A	11/16	0.688	0.588	160	2,027
W719A	23/32	0.719	0.619	152	1,926
W750A	3/4	0.750	0.650	144	1,824
W781A	25/32	0.781	0.681	133	1,685
W812A	13/16	0.812	0.712	133	1,685
W875A	7/8	0.875	0.775	126	1,596



Air Spacer

A-Profile Air Spacer

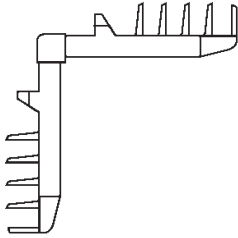

**Nylon FlexiFin
Fixed 90° Corner Key**

Part Number	Fractional Size	Key Part Number	Pieces per Box
W188A	3/16	DWA188P	8,000
W250A	1/4	DWA250P	6,200
W297A	19/64	DWA297P	4,600
W312A	5/16	DWA312P	4,200
W360A	23/64	DWA360P	3,800
W375A	3/8	DWA375P	3,600
W406A	13/32	DWA406P	3,400
W438A	7/16	DWA438P	3,200
W469A	15/32	DWA469P	3,000
W500A	1/2	DWA500P	2,600
W531A	17/32	DWA531P	2,400
W563A	9/16	DWA563P	2,400
W594A	19/32	DWA594P	2,300
W625A	5/8	DWA625P	2,200
W656A	21/32	DWA656P	2,100
W688A	11/16	DWA688P	2,000
W719A	23/32	DWA719P	1,900
W750A	3/4	DWA750P	1,800
W812A	13/16	DWA812P	1,500
W875A	7/8	DWA875P	1,400



Air Spacer

A-Profile Air Spacer

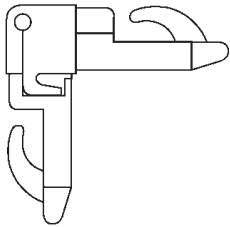

**Nylon Fold & Lock
Corner Key with Hook**

Part Number	Fractional Size	Key Part Number	Pieces per Box
W188A	3/16	D188A	5,000
W219A	7/32	D219A	4,500
W250A	1/4	D250A	4,000
W281A	9/32	D281A	3,500
W297A	19/64	D281A	3,500
W312A	5/16	D312A	3,200
W344A	11/32	D344A	3,000
W375A	3/8	D375A	2,500
W406A	13/32	D406A	2,500
W438A	7/16	D438A	2,300
W469A	15/32	D469A	2,100
W500A	1/2	D500A	1,900
W531A	17/32	D531A	1,800
W563A	9/16	D563A	1,800
W594A	19/32	D594A	1,600
W625A	5/8	D625A	1,600
W656A	21/32	D656A	1,500
W688A	11/16	D688A	1,500
W719A	23/32	D719A	1,300
W750A	3/4	D750A	1,300



Air Spacer

A-Profile Air Spacer

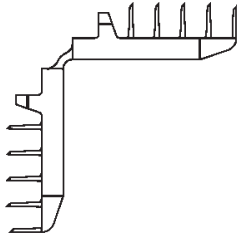

**Nylon FlexiFin
Bending Corner Key**

Part Number	Fractional Size	Key Part Number	Pieces per Box
W188A	3/16	DF188SWA-1	8,000
W250A	1/4	DF250SWA	6,200
W312A	5/16	DF312SWA	4,200
W375A	3/8	DF375SWA	3,600
W438A	7/16	DF438SWA	3,200
W469A	15/32	DF469SWA	3,000
W500A	1/2	DF500SWA	2,600
W531A	17/32	DF531SWA	2,600
W563A	9/16	DF563SWA	2,400
W594A	19/32	DF594SWA	2,300
W625A	5/8	DF625SWA	2,200
W656A	21/32	DF656SWA	2,100
W688A	11/16	DF688SWA	2,000
W719A	23/32	DF719SWA	1,900
W750A	3/4	DF750SWA	1,800



Air Spacer

A-Profile Air Spacer

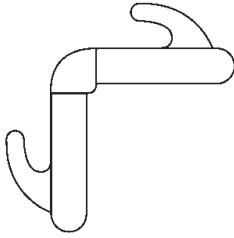

**Nylon Fixed 90° Corner Key
with Hook**

Part Number	Fractional Size	Key Part Number	Pieces per Box
W188A	3/16	DWA188HK	4,000
W250A	1/4	DWA250HK	2,400
W312A	5/16	DWA312HK	2,000
W375A	3/8	DWA375HK	1,600
W438A	7/16	DWA438HK	1,500
W500A	1/2	DWA500HK	1,000
W563A	9/16	DWA563HK	1,000
W625A	5/8	DWA625HK	800
W688A	11/16	DWA688HK	500
W750A	3/4	DWA750HK	500



Air Spacer

A-Profile Air Spacer

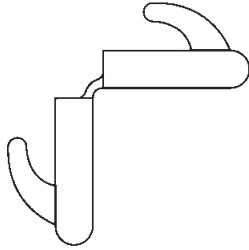

**Nylon Bending
Corner Key with Hook**

Part Number	Fractional Size	Key Part Number	Pieces per Box
W188A	3/16	D188SWAHK	4,000
W250A	1/4	D250SWAHK	3,500
W312A	5/16	D312SWAHK	2,800
W375A	3/8	D375SWAHK	2,400
W438A	7/16	D438SWAHK	1,800
W500A	1/2	D500SWAHK	1,500
W563A	9/16	D563SWAHK	1,200
W625A	5/8	D625SWAHK	1,000
W688A	11/16	D688SWAHK	3,000
W750A	3/4	D750SWAHK	800



Air Spacer

A-Profile Air Spacer

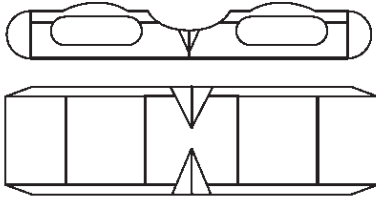

Nylon Straight Connector

Part Number	Fractional Size	Key Part Number	Pieces per Box
W188A	3/16	DW188MPST	7,500
W219A	7/32	DW219MPST	6,000
W250A	1/4	DW250MPST-1	1,800
W312A	5/16	DW312MPST	1,200
W344A	11/32	DW344MPST	3,500
W406A	13/32	DW406MPST	900
W469A	15/32	DW469MPST	3,500
W500A	1/2	DW500MPST-1	800
W594A	19/32	DW594MPST	2,000
W688A	11/16	DW688MPST	1,600



Air Spacer

A-Profile Air Spacer

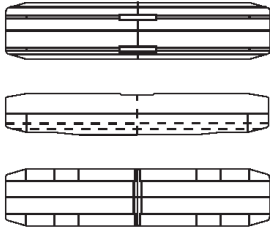

**Nylon Straight Connector -
Pass Desiccant**

Part Number	Fractional Size	Key Part Number	Pieces per Box
W188A	3/16	DW188MPSTPD-1	8,000
W250A	1/4	DW250MPSTPD-1	6,500
W312A	5/16	DW312MPSTPD-1	6,000
W344A	11/32	DW344MPSTPD	1,700
W375A	3/8	DW375MPSTPD	1,600
W438A	7/16	DW438MPSTPD-1	3,200
W469A	15/32	DW469MPSTPD	800
W500A	1/2	DW500MPSTPD-1	2,800
W531A	17/32	DW531MPSTPD	700
W563A	9/16	DW563MPSTPD-1	2,400
W594A	19/32	DW594MPSTPD-1	2,400
W625A	5/8	DW625MPSTPD-1	2,300
W656A	21/32	DW656MPSTPD	600
W688A	11/16	DW688MPSTPD-1	2,100
W719A	23/32	DW719MPSTPD-1	2,000
W750A	3/4	DW750MPSTPD	600



Air Spacer

A-Profile Air Spacer

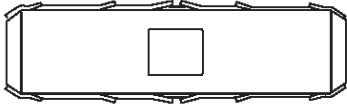

Steel Straight Connector

Part Number	Fractional Size	Key Part Number	Pieces per Box
W250A	1/4	DF6.5ST	2,500
W297A	19/64	DF7.5ST	2,500
W312A	5/16	DF8.0ST	2,500
W375A	3/8	DF9.5ST	2,500
W500A	1/2	DF12.5ST	2,500
W531A	17/32	DF13.5ST	2,500
W625A	5/8	DF16.0ST	2,000
W688A	11/16	DF17.5ST	1,500
W750A	3/4	DF19.0ST	1,500



Air Spacer

Thermal Edge Low Profile Air Spacer (TEF)

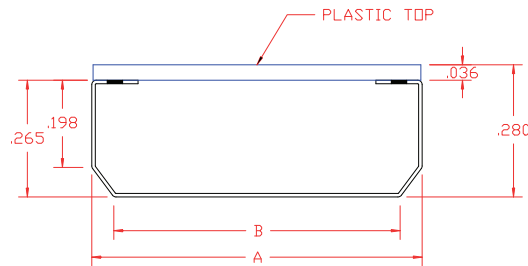

Hygrade's Low Profile Thermal Edge product is a uniquely designed, efficient and cost-effective warm edge spacer with the following benefits:

- Superior combination of thermal efficiency and structural strength
- True warm edge benefits: Increased edge temperature and reduced perimeter condensation
- Precisely formed rigid steel base with UV resistant polymer cap
- Available in low profile and Heat Mirror compatible profiles
- Available in White, Grey, Light Grey and Black
- Bendable with traditional metal spacer benders
- Easy to fill with desiccant
- Requires no new capital equipment
- Compatible with and enhances performance of Low-E coatings and gas filling

Related Connectors

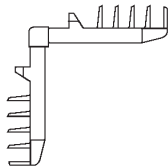

Nylon FlexiFin
Fixed 90° Fixed Corner Key

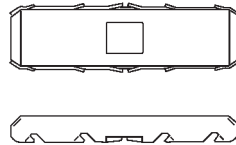

Steel Straight Connector



Air Spacer

Thermal Edge Low Profile Air Spacer (TEF)

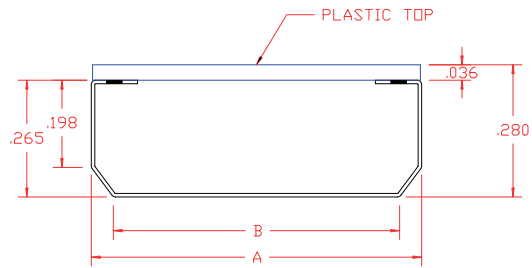

Part Number	Fractional Size	Air Space in Inches (A)	(B) in Inches	Pieces per Carton	Linear Feet per Carton based on 156"
TEF250	1/4	0.250	0.144	264	3,432
TEF312	5/16	0.312	0.206	204	2,652
TEF375	3/8	0.375	0.269	168	2,184
TEF438	7/16	0.438	0.333	144	1,872
TEF468	15/32	0.468	0.366	132	1,716
TEF500	1/2	0.500	0.400	132	1,716
TEF531	17/32	0.531	0.426	120	1,560
TEF563	9/16	0.562	0.458	108	1,404
TEF594	19/32	0.594	0.490	108	1,404
TEF625	5/8	0.625	0.521	96	1,248
TEF688	11/16	0.688	0.583	96	1,248
TEF750	3/4	0.750	0.650	84	1,092



Air Spacer

Thermal Edge Low Profile Air Spacer (TEF)

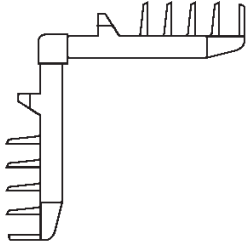

**Nylon FlexiFin
Fixed 90° Fixed Corner Key**

Part Number	Fractional Size	Key Part Number	Pieces per Box
TEF250	1/4	DTE250	2,500
TEF312	5/16	DTE312	2,500
TEF375	3/8	DTE375	2,500
TEF406	13/32	DTE406	2,500
TEF438	7/16	DTE438	2,500
TEF468	15/32	DTE468	2,500
TEF500	1/2	DTE500	2,500
TEF531	17/32	DTE531	2,500
TEF563	9/16	DTE563	2,500
TEF594	19/32	DTE594	2,500
TEF605	39/64	DTE605	2,500
TEF625	5/8	DTE625	2,500
TEF640	41/64	DTE640	2,500
TEF688	11/16	DTE688	2,500
TEF750	3/4	DTE750	2,500
TEF812	13/16	DTE812	2,500



Air Spacer

Thermal Edge Low Profile Air Spacer (TEF)

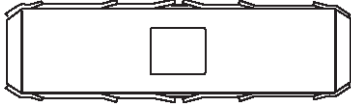

Steel Straight Connector

Part Number	Fractional Size	Key Part Number	Pieces per Box
TEF468	15/32	DTE468ST	2,500
TEF500	1/2	DTE500ST	2,500
TEF563	9/16	DTE563ST	2,500
TEF625	5/8	DTE625ST	2,500
TEF750	3/4	DTE750ST	2,500



Thermal Edge Heat Mirror Profile Air Spacer (TEH)

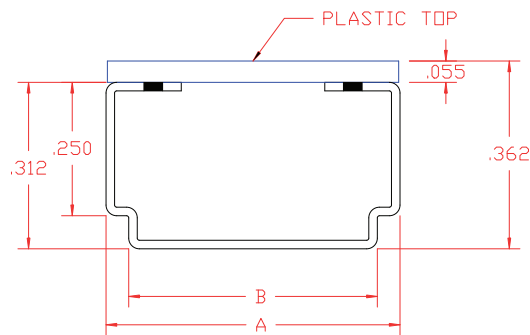

Hygrade's Heat Mirror Thermal Edge product has all the same benefits of the Low Profile Thermal Edge Product, but is approved for use in Heat Mirror applications. This uniquely designed, efficient and cost-effective warm edge spacer has the following benefits:

- Superior combination of thermal efficiency and structural strength
- True warm edge benefits: Increased edge temperature and reduced perimeter condensation
- Precisely formed rigid steel base with UV resistant polymer cap
- Heat Mirror compatible profile
- Available in White, Grey, Light Grey and Black
- Bendable with traditional metal spacer benders
- Easy to fill with desiccant
- Requires no new capital equipment
- Compatible with and enhances performance of Low-E coatings and gas filling

Related Connectors

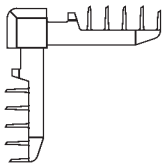

**Wraparound Glass Filled
Nylon Corner Key**

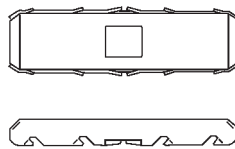

Steel Straight Connector



Air Spacer

Thermal Edge Heat Mirror Profile Air Spacer (TEH)

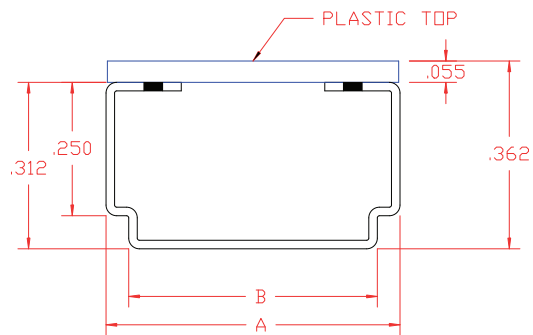

Part Number	Air Space in Decimal (A)	Air Space in MM (A)	(B) in Inches	Pieces per Carton	Linear Feet per Carton based on 156"
TEH6MM	0.236	6	0.151	200	2,600
TEH7MM	0.276	7	0.190	180	2,340
TEH8MM	0.315	8	0.315	170	2,210
TEH9MM	0.354	9	0.354	140	1,820
TEH12MM	0.472	12	0.472	99	1,287
TEH14MM	0.551	14	0.551	90	1,170



Thermal Edge Heat Mirror Profile Air Spacer (TEH)

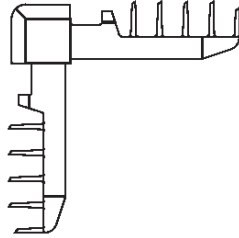

**Wraparound Glass Filled
Nylon Corner Key**

Part Number	Air Space in Decimal	Air Space in MM	Key Part Number	Pieces per Box
TEH6MM	0.236	6	D235ATGF-1	3,800
TEH7MM	0.276	7	D281ATGF-1	3,300
TEH8MM	0.315	8	D312ATGF-1	3,000
TEH9MM	0.354	9	D359ATGF-1	2,600



Air Spacer

Thermal Edge Heat Mirror Profile Air Spacer (TEH)

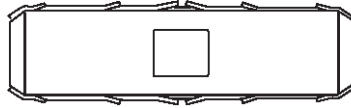

Steel Straight Connector

Part Number	Air Space in Decimal	Air Space in MM	Key Part Number	Pieces per Box
TEH7MM	0.276	7	DTE7MMST	2,500
TEH8MM	0.315	8	DTE8MMST	2,500
TEH9MM	0.354	9	DTE9MMST	2,500



Air Spacer

WH (250P) Air Spacer

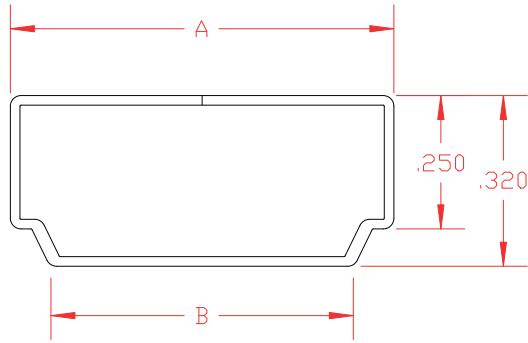

Laser-welded air spacers are available in mill finish, clear, light bronze, dark bronze, black and gold anodized aluminum, and galvanized and HY-NZ (Nickel Zinc coated) steel. Spacers can be imprinted or cut-to-length. Zipper welds or solid welds with perforated top can be specified.

Standard lengths are 12'8" or 13' depending on the profile.

Related Connectors

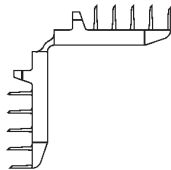

**Nylon FlexiFin Bending
Corner Key**

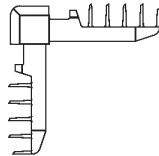

**Glass Filled Nylon
Wraparound Corner Key**

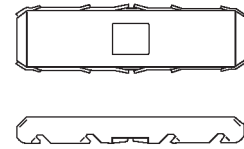

Steel Straight Connector



Air Spacer

WH (250P) Air Spacer

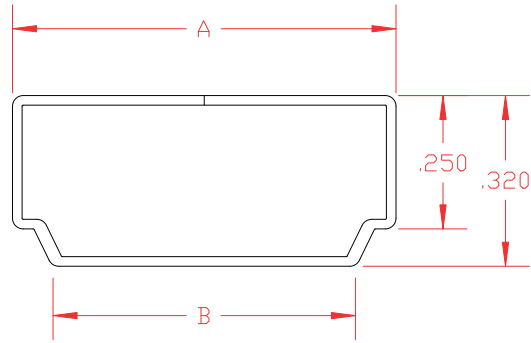

Part Number	Fractional Size	MM Size	Air Space in Inches (A)	(B) in Inches	Pieces per Carton	Linear Feet per Carton based on 156"
WHG188	3/16	4.78	0.188	0.044	350	4,550
WHG219	7/32	5.50	0.219	0.075	150	1,950
WHG230	15/64	6.00	0.230	0.086	450	5,850
WHG250	1/4	6.35	0.250	0.106	100	1,300
WHG281	9/32	7.00	0.281	0.137	185	2,405
WHG312	5/16	8.00	0.312	0.168	185	2,405
WHG8MM	0.315	8.00	0.315	0.171	185	2,405
WHG324	0.324	8.23	0.324	0.181	360	4,680
WHG344	11/32	8.74	0.344	0.201	150	1,950
WHG9MM	0.354	9.00	0.354	0.211	150	1,950
WHG375	3/8	9.50	0.375	0.232	150	1,950
WHG406	13/32	10.32	0.406	0.262	285	3,705
WHG438	7/16	11.13	0.438	0.293	120	1,560
WHG469	15/32	11.92	0.469	0.325	120	1,560
WHG485	31/64	12.32	0.485	0.340	228	2,964
WHG500	1/2	12.70	0.500	0.356	50	650
WHG520		13.21	0.520	0.376	200	2,600
WHG531	17/32	13.50	0.531	0.387	198	2,574
WHG563	9/16	14.31	0.563	0.419	112	1,456
WHG594	19/32	15.00	0.594	0.450	190	2,470
WHG656	21/32	16.70	0.656	0.512	171	2,223
WHG719	23/32	18.27	0.719	0.575	152	1,976
WHG733	47/64	18.62	0.733	0.588	152	1,976

Air Spacer



Air Spacer

WH (250P) Air Spacer

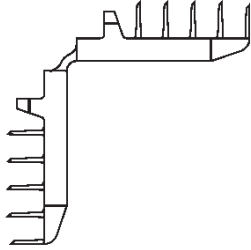

**Nylon FlexiFin
Bending Corner Key**

Part Number	Fractional Size	Key Part Number	Pieces per Box
WHG219	7/32	D219SWA	6,500
WHG250	1/4	D250SWA	6,200
WHG281	9/32	D281SWA	5,400
WHG312	5/16	D312SWA	4,200
WHG344	11/32	D344SWA	4,000
WHG375	3/8	D375SWA	3,600
WHG438	7/16	D438SWA	3,200
WHG469	15/32	D469SWA	3,300
WHG500	1/2	D500SWA	2,600
WHG531	17/32	D531SWA	2,600
WHG563	9/16	D563SWA	2,400
WHG594	19/32	D594SWA	2,300
WHG625	5/8	D625SWA	2,200
WHG656	21/32	D656SWA	2,100
WHG688	11/16	D688SWA	2,000
WHG719	23/32	D719SWA	1,900
WHG750	3/4	D750SWA	1,800



Air Spacer

WH (250P) Air Spacer

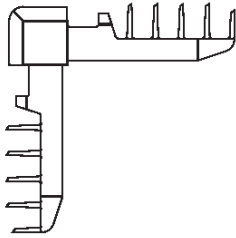

**Glass Filled Nylon
Wraparound Corner Key**

Part Number	Fractional Size	Key Part Number	Pieces per Box
WHG250	1/4	D250ATGF	1,000 / 3,700
WHG281	9/32	D281ATGF	1,000
WHG312	5/16	D312ATGF-1	3,000
WHG8MM		D312ATGF-1	3,000
WHG344	11/32	D344ATGF-1	2,700
WHG9MM		D375ATGF-1	2,400
WHG375	3/8	D375ATGF-1	2,400
WHG438	7/16	D438ATGF-1	1,900
WHG485	31/64	D469ATGF-1	1,800
WHG500	1/2	D500ATGF-1	1,700
WHG594	19/32	D594ATGF-1	1,300
WHG656	21/32	D656ATGF-1	1,200
WHG719	23/32	D719ATGF-1	1,000
WHG750	3/4	D750ATGF	300



Air Spacer

WH (250P) Air Spacer

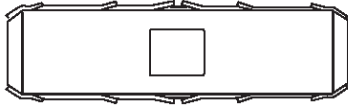

Steel Straight Connector

Part Number	Fractional Size	Key Part Number	Pieces per Box
WHG219	7/32	D219ST	2,500
WHG250	1/4	D250ST	2,500
WHG344	11/32	D344ST	2,500
WHG485	31/64	D485ST	2,500
WHG594	19/32	D594ST	2,000



Air Spacer

P.I.B Groove Air Space

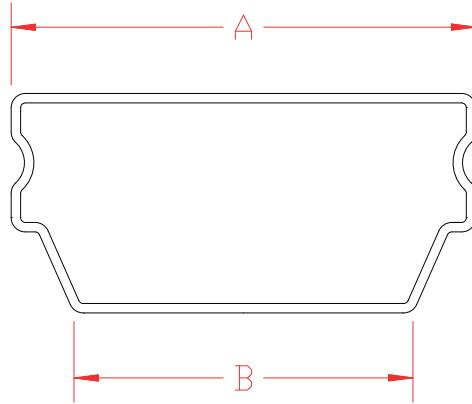

Laser-welded air spacers are available in mill finish, clear, light bronze, dark bronze, black and gold anodized aluminum, and galvanized and HY-NZ (Nickel Zinc coated) steel. Spacers can be imprinted or cut-to-length. Zipper welds or solid welds with perforated top can be specified.

Standard lengths are 12'8" or 13' depending on the profile.

Related Connectors

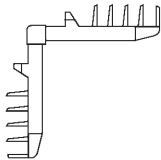

**Nylon FlexiFin
Fixed 90° Corner Key**



Air Spacer

P.I.B Groove Air Space

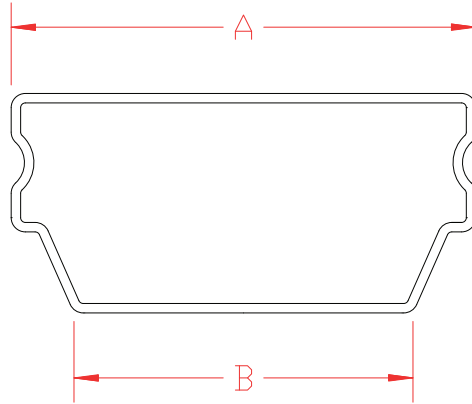

Part Number	Fractional Size	Air Space in Inches (A)	(B) in Inches	Pieces per Carton	Linear Feet per Carton based on 156"
WDS219	7/32	0.219	0.070	475	6,175
WDS235	15/64	0.235	0.086	450	5,850
WDS250	1/4	0.250	0.092	425	5,525
WDS281	9/32	0.281	0.100	400	5,200
WDS297	19/64	0.297	0.116	400	5,200
WDS312	5/16	0.312	0.132	375	7,375
WDS344	11/32	0.344	0.150	330	4,290
WDS360	23/64	0.360	0.166	300	3,900
WDS406	13/32	0.406	0.182	275	3,575
WDS423	27/64	0.423	0.196	266	3,458
WDS438	7/16	0.438	0.212	216	2,808
WDS469	15/32	0.469	0.286	234	3,042
WDS485	31/64	0.485	0.302	228	2,964
WDS500	1/2	0.500	0.316	225	2,925
WDS531	17/32	0.531	0.306	216	2,808
WDS548	35/64	0.548	0.322	209	2,717
WDS563	9/16	0.563	0.338	162	2,106
WDS594	19/32	0.594	0.375	170	2,210
WDS610	39/64	0.610	0.391	180	2,340
WDS625	5/8	0.625	0.427	190	2,340
WDS673	43/64	0.673	0.486	162	2,106
WDS688	11/16	0.688	0.502	162	2,106
WDS719	23/32	0.719	0.494	150	1,950
WDS735	47/64	0.735	0.510	144	1,872
WDS750	3/4	0.750	0.526	152	1,976



Air Spacer

P.I.B Groove Air Space

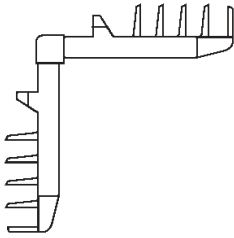

**Nylon FlexiFin
Fixed 90° Corner Key**

Part Number	Fractional Size	Key Part Number	Pieces per Box
WDS235	15/64	DW188P	4,500
WDS250	1/4	DW188P	4,500
WDS297	19/64	DW250P	11,000
WDS344	11/32	DW312P-1	2,800
WDS360	23/64	DW312P-1	2,800
WDS423	27/64	DW375P	7,000
WDS438	7/16	DW375P	7,000
WDS469	15/32	DW438P	6,000
WDS485	31/64	DW438P	6,000
WDS548	35/64	DW500P	6,000
WDS594	19/32	DW563P	5,000
WDS610	39/64	DW563P	5,000
WDS625	5/8	DW563P	5,000
WDS673	43/64	DW656P	4,000
WDS735	47/64	DW688P	4,000



Air Spacer

Rectangular Profile Air Spacer

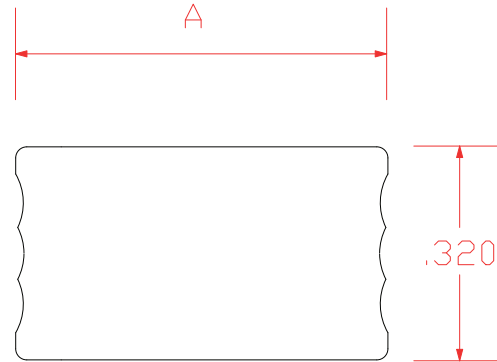

Laser-welded air spacers are available in mill finish, clear, light bronze, dark bronze, black and gold anodized aluminum, and galvanized and HY-NZ (Nickel Zinc coated) steel. Spacers can be imprinted or cut-to-length. Zipper welds or solid welds with perforated top can be specified.

Standard lengths are 12'8" or 13' depending on the profile.

Related Connectors

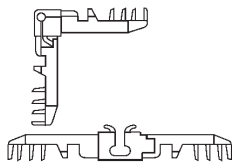

**Nylon Fold & Lock
Corner Key**



Air Spacer

Rectangular Profile Air Spacer

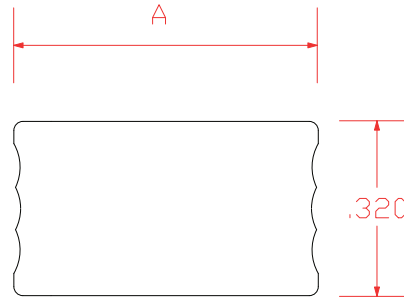

Part Number	Fractional Size	Air Space in Inches (A)	Pieces per Carton	Linear Feet per Carton based on 156"
WR125	1/8	0.125	250	3,250
WR156	5/32	0.156	375	4,875
WR188	3/16	0.188	300	3,900
WR219	7/32	0.219	250	3,250
WR235	15/64	0.235	400	5,200
WR250	1/4	0.250	400	5,200
WR265	17/64	0.265	350	4,550
WR281	9/32	0.281	350	4,550
WR297	19/64	0.297	350	4,550
WR312	5/16	0.312	360	4,680
WR344	11/32	0.344	300	3,900
WR360	23/64	0.360	265	3,445
WR375	3/8	0.375	265	3,445
WR406	13/32	0.406	266	3,458
WR438	7/16	0.438	266	3,458
WR469	15/32	0.469	234	3,042
WR485	31/64	0.485	216	2,808
WR500	1/2	0.500	216	2,808
WR512	.512	0.512	216	2,808
WR522	.522	0.522	200	2,600
WR531	17/32	0.531	209	2,717
WR563	9/16	0.533	180	2,340
WR594	19/32	0.594	180	2,340
WR625	5/8	0.625	170	2,210
WR656	21/32	0.656	162	2,106
WR688	11/16	0.688	152	1,976
WR719	23/32	0.719	144	1,872
WR750	3/4	0.750	152	1,976
WR781	25/32	0.781	136	1,768
WR812	13/16	0.812	108	1,404
WR844	27/32	0.844	216	2,808



Rectangular Profile Air Spacer

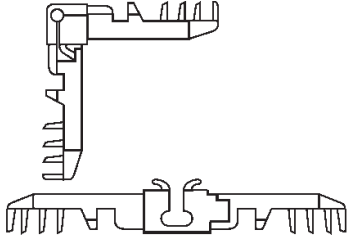

Nylon Fold & Lock Corner Key

Part Number	Fractional Size	Key Part Number	Pieces per Box
WR156	5/32	DR156A	1,800
WR188	3/16	DR188A	1,600
WR219	7/32	DR219A	4,200
WR235	15/64	DR235A	3,800
WR250	1/4	DR250A	3,600
WR265	17/64	DR265A	3,600
WR281	9/32	DR281A	3,400
WR297	19/64	DR297A	3,200
WR312	5/16	DR312A	3,000
WR344	11/32	DR344A	2,800
WR360	23/64	DR360A	2,600
WR375	3/8	DR375A	2,500
WR406	13/32	DR406A	2,400
WR438	7/16	DR438A	2,200
WR469	15/32	DR469A	2,000
WR485	31/64	DR469A	2,000
WR500	1/2	DR500A	1,800
WR512	0.512	DR512A	1,800
WR522	0.522	DR512A	1,800
WR531	17/32	DR531A	1,700
WR563	9/16	DR563A	1,600
WR594	19/32	DR594A	1,500
WR625	5/8	DR625A	1,400
WR656	21/32	DR656A	1,300
WR688	11/16	DR688A	1,300
WR719	23/32	DR719A	1,200
WR750	3/4	DR750A	1,200
WR781	25/32	DR781A	1,200
WR812	13/16	DR812A	1,200



Air Spacer

LPD-Profile Air Spacer

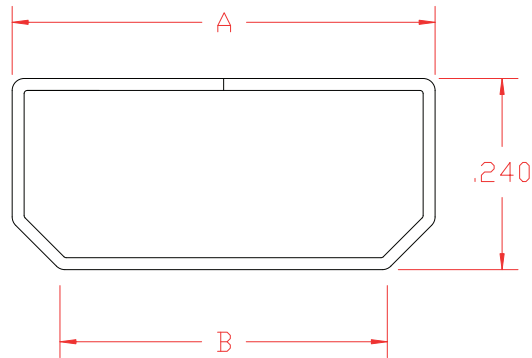

Laser-welded air spacers are available in mill finish, clear, light bronze, dark bronze, black and gold anodized aluminum, and galvanized and HY-NZ (Nickel Zinc coated) steel. Spacers can be imprinted or cut-to-length. Zipper welds or solid welds with perforated top can be specified.

Standard lengths are 12'8" or 13' depending on the profile.

Related Connectors

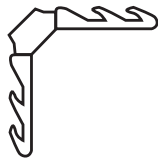

Gas Filling Key with Hole

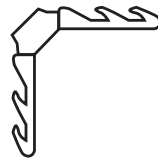

Gas Filling Key without Hole

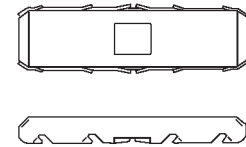

Steel Straight Connector

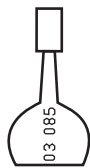

Plug for Gas Filling Key

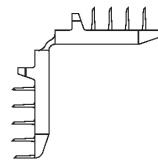

Nylon FlexiFin Bending Corner Key



Air Spacer

LPD-Profile Air Spacer

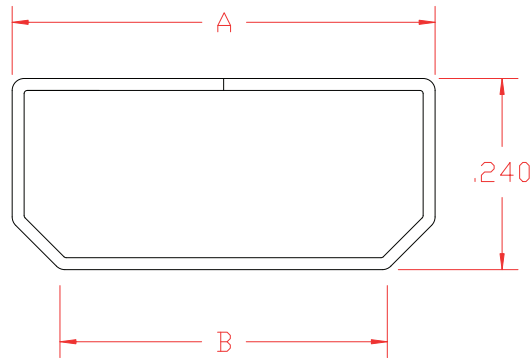

Part Number	Decimal Size	Air Space in Inches (A)	(B) in Inches	Pieces per Carton	Linear Feet per Carton based on 156"
5.5 LPD	0.216	0.216	0.097	300	3,900
6.0 LPD	0.236	0.236	0.116	300	3,900
6.5 LPD	0.256	0.256	0.133	300	3,900
7.0 LPD	.0276	.0276	0.156	250	3,250
7.5 LPD	0.296	0.296	0.175	250	3,250
8.0 LPD	0.315	0.315	0.195	220	2,860
8.5 LPD	0.335	0.335	0.219	210	2,730
9.0 LPD	0.354	0.354	0.234	204	2,652
9.5 LPD	0.374	0.374	0.254	200	2,600
10.0 LPD	0.394	0.394	0.274	190	2,470
11.5 LPD	0.453	0.453	0.333	300	3,900
12.0 LPD	0.472	0.472	0.352	285	3,705
12.5 LPD	0.492	0.492	0.372	276	3,588
13.5 LPD	0.531	0.531	0.411	250	3,250
14.5 LPD	0.571	0.571	0.451	240	3,120
15.5 LPD	0.610	0.610	0.490	210	2,730
16.0 LPD	0.630	0.630	0.651	216	2,808
16.5 LPD	0.650	0.650	0.530	225	2,925
17.5 LPD	0.689	0.689	0.569	195	2,535
18.0 LPD	0.709	0.709	0.589	184	2,392
18.5 LPD	0.728	0.728	0.608	184	2,392
19.0 LPD	0.748	0.748	0.628	192	2,496
19.5 LPD	0.768	0.768	0.648	192	2,496
20.0 LPD	0.787	0.787	0.667	185	2,405



Air Spacer

LPD-Profile Air Spacer

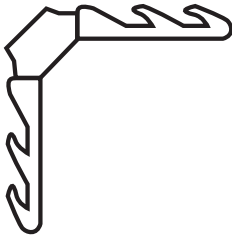

**Gas Filling Key
with Hole**

Part Number	Decimal Size	Key Part Number	Pieces per Box
5.5 LPD	0.216	D5.5GFH	5,000
6.0 LPD	0.236	D6GFH	2,700
6.5 LPD	0.256	D6.5GFH/-2	2,000 / 1,000
7.5 LPD	0.295	D7.5GFH	5,000
8.0 LPD	0.315	D8GFH	5,000
9.5 LPD	0.374	D9.5GFH/-1	5,000 / 1,000
11.5 LPD	0.453	D11.5GFH	5,000
12.5 LPD	0.492	D12.5GFH	5,000
13.5 LPD	0.531	D13.5GFH	5,000
14.5 LPD	0.571	D14.5GFH	4,000
15.5 LPD	0.610	D15.5GFH/-1	4,000 / 1,000
16.0 LPD	0.630	D16GFH	3,500
17.5 LPD	0.689	D17.5GFH	3,500
18.5 LPD	0.728	D18.5GFH	3,500
19.5 LPD	0.768	D19.5GFH	3,500
21.5 LPD	0.646	D21.5GFH	3,000

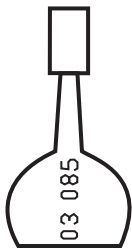

Plug for Gas Filling Key

Part Number	Plug Part Number	Pieces per Box
5.5 LPD to 7.5 LPD	DP3.5	5,000
8.0 LPD to 21.5 LPD	DP5.3	5,000
5.5 LPD to 8.0 LPD	PLUG-7.2	5,000
8.5 LPD to 21.5 LPD	PLUG-8.5	5,000



Air Spacer

LPD-Profile Air Spacer

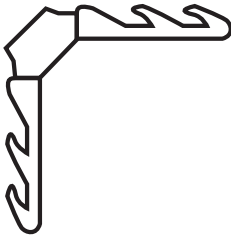

**Gas Filling Key
without Hole**

Part Number	Decimal Size	Key Part Number	Pieces per Box
5.5 LPD	0.216	D5.5GF	5,000
6.0 LPD	0.236	D6GF	2,700
6.5 LPD	0.256	D6.5GF/-2	5,000 / 2,000
7.5 LPD	0.295	D7.5GF	5,000
8.0 LPD	0.315	D8GF	5,000
9.5 LPD	0.374	D9.5GF/-1	5,000 / 1,000
11.5 LPD	0.453	D11.5GF	5,000
12.5 LPD	0.492	D12.5GF	5,000
13.5 LPD	0.531	D13.5GF	5,000
14.5 LPD	0.571	D14.5GF	4,000
15.5 LPD	0.610	D15.5GF/-1	4,000 / 1,000
16.0 LPD	0.630	D16GF	3,500
17.5 LPD	0.689	D17.5GF	3,500
18.5 LPD	0.728	D18.5GF	3,500
19.5 LPD	0.768	D19.5GF	3,500
21.5 LPD	0.646	D21.5GF	3,000



Air Spacer

LPD-Profile Air Spacer

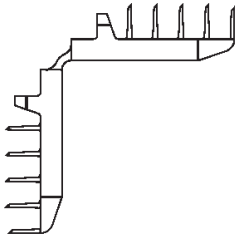

**Nylon FlexiFin Bending
Corner Key**

Part Number	Decimal Size	Key Part Number	Pieces per Box
10.0 LPD	0.394	DF10SWA	4,800
12.0 LPD	0.472	DF12SWA	3,800
16.0 LPD	0.630	DF16SWA	3,000
18.5 LPD	0.728	DF18.5SWA	2,500
20.0 LPD	0.787	DF20SWA	2,200

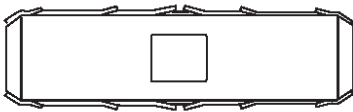

Steel Straight Connector

Part Number	Decimal Size	Key Part Number	Pieces per Box
5.5 LPD	0.216	DF4.5ST	2,500
6.5 LPD	0.256	DF6.5ST	2,500
8.0 LPD	0.315	DF8.0ST	2,500
9.5 LPD	0.374	DF9.5ST	2,500
11.5 LPD	0.453	DF11.0ST	2,500
12.5 LPD	0.492	DF12.5ST	2,500
14.5 LPD	0.571	DF14.5ST	2,500
16.0 LPD	0.630	DF16.0ST	2,000
17.0 LPD	0.669	DF17.0STAM	1,500
17.5 LPD	0.689	DF17.5ST	1,500
19.0 LPD	0.748	DF19.0ST	1,500